

TDE Instruments

Digalox® DPM72 AV / AVP
Application example
Switchable multimeter

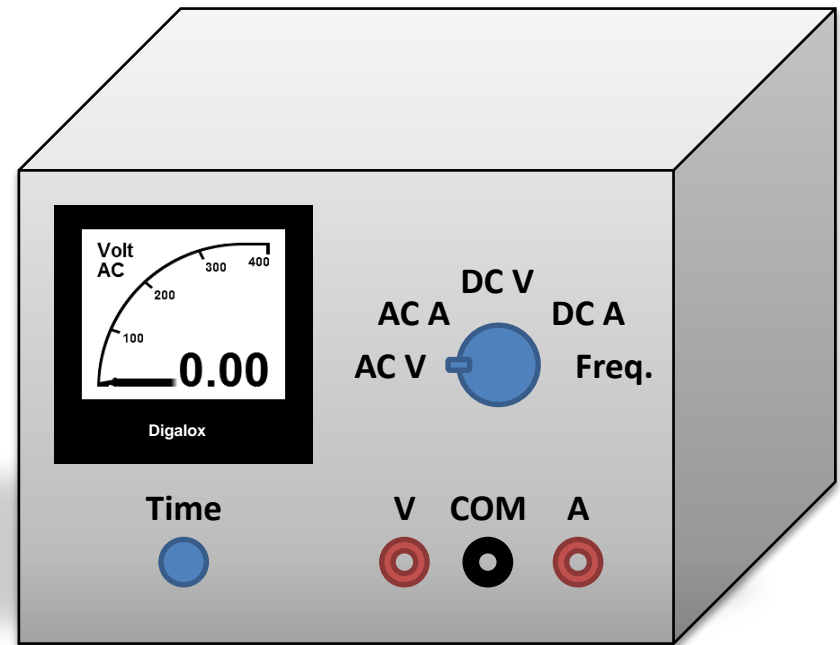

TDE Instruments GmbH
Gewerbestraße 8
D-71144 Steinenbronn
Info@tde-instruments.de

Application example switchable multimeter

- Measurement of current, voltage and frequency
- Switching of the measurement mode via a 5-way turn knob
- Switching of the timebased view via a switch

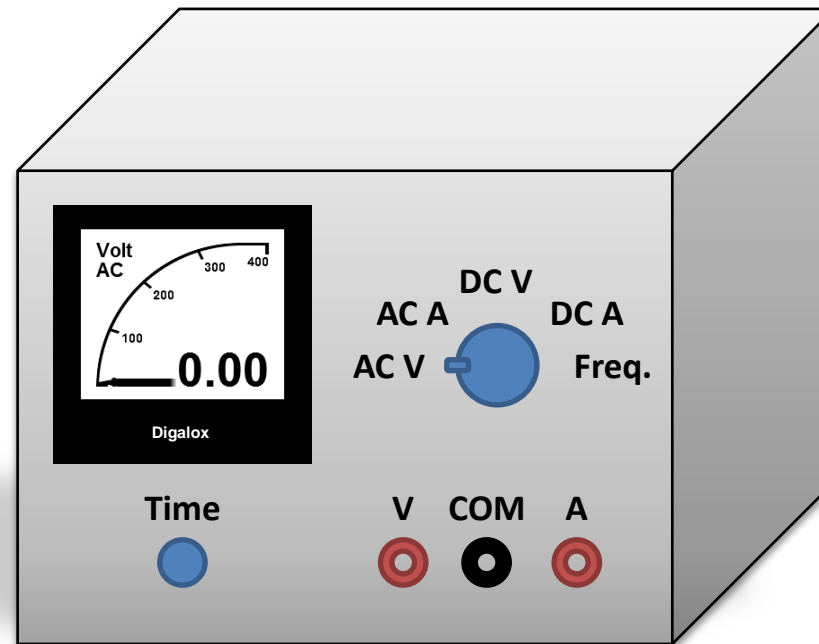

Application example switchable multimeter

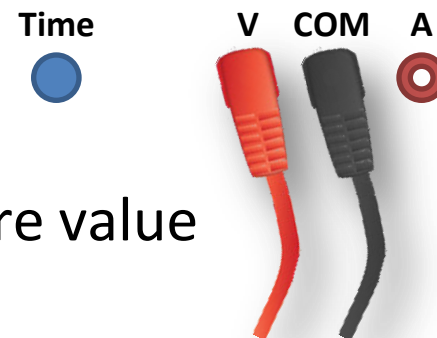
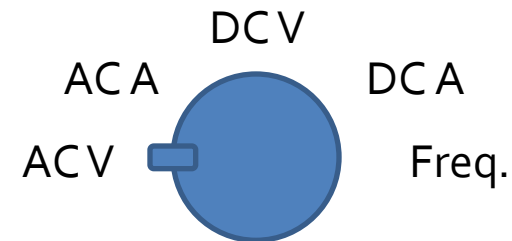
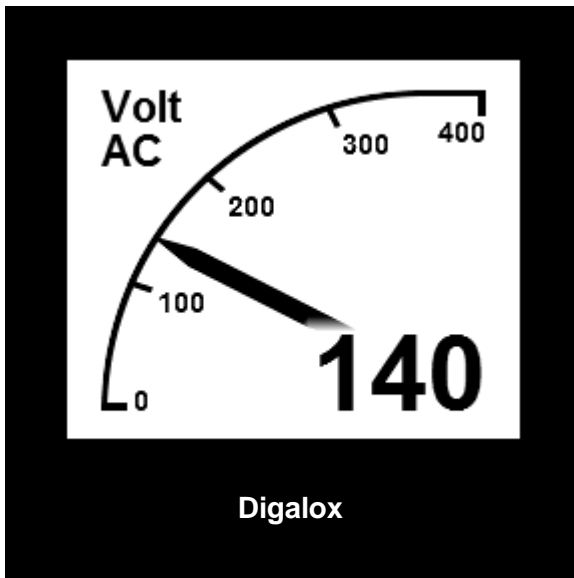

- Display range adjusts to measure value (can be activated/deactivated)

Application example switchable multimeter

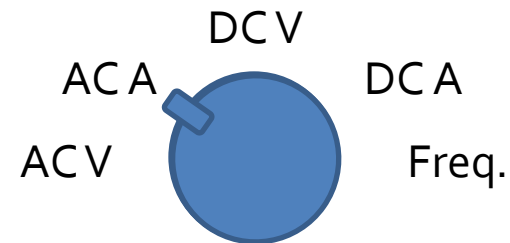
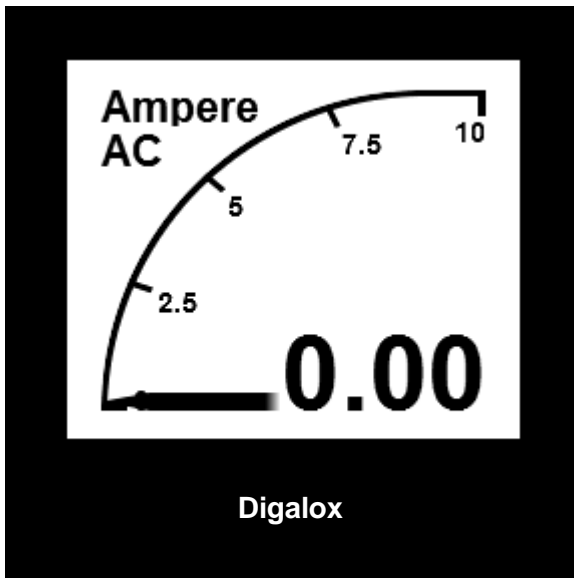

Time



V



COM



A



- Measurement mode can be selected using the turn knob

Application example switchable multimeter

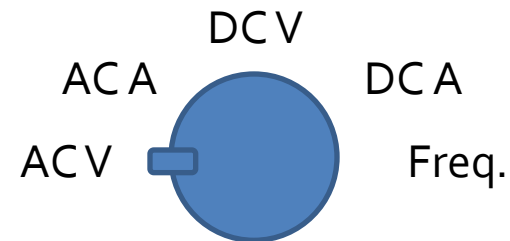
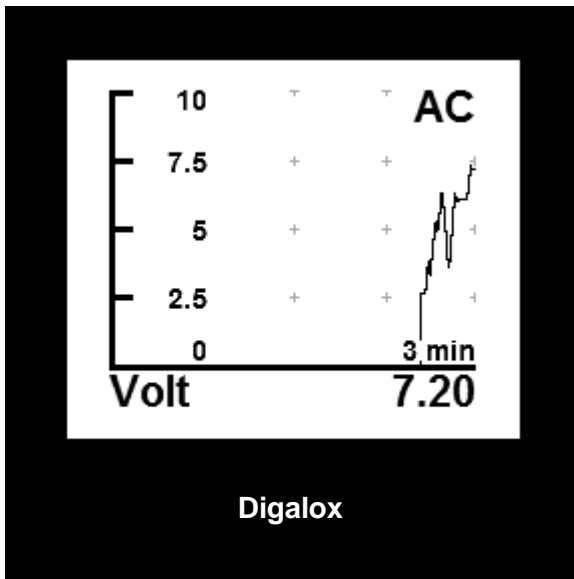

- Timebased view is activated by the switch

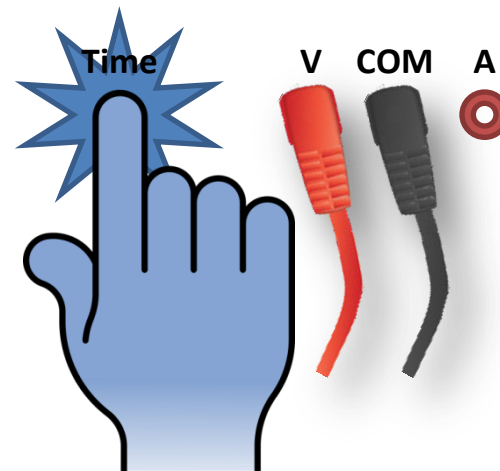

Application example switchable multimeter

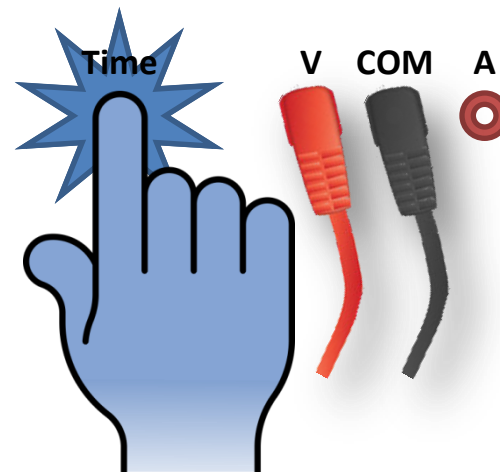
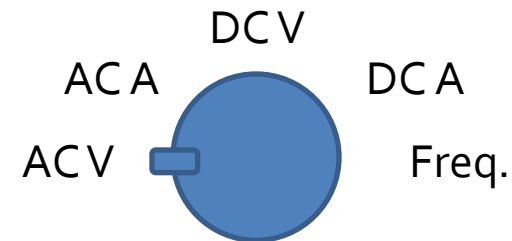
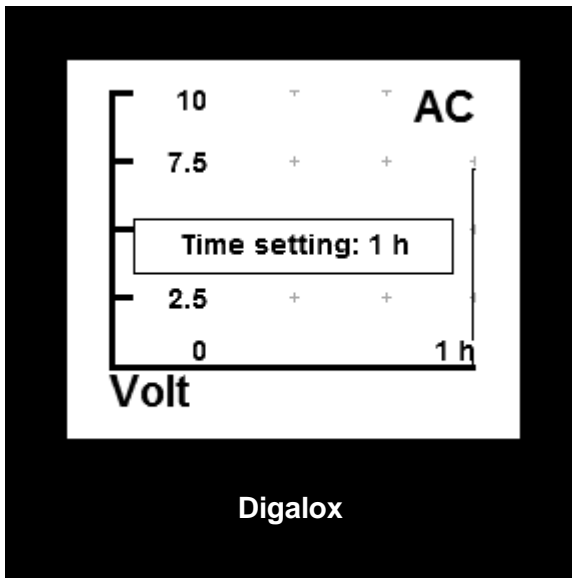

- Timebase can be changed by quickly tapping switch (3 minutes to 14 days)

Connection of the unit

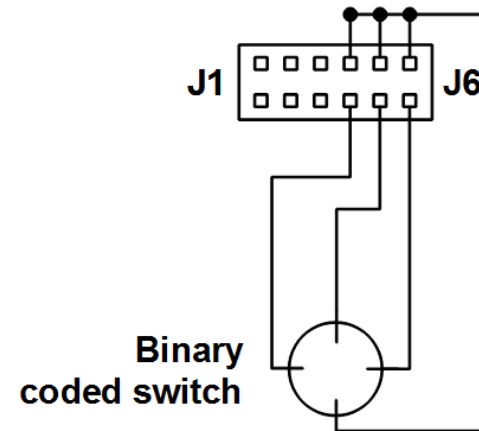
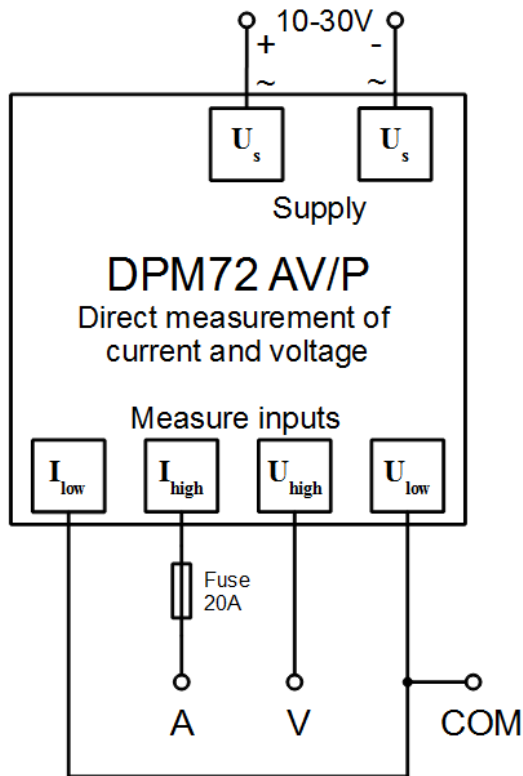

TDE Instruments

Thank you for your
attention!

TDE Instruments GmbH
Gewerbestraße 8
D-71144 Steinenbronn
Info@tde-instruments.de
+49 7157 20801

