



## Digalox® DPM72-MPN<sup>+</sup>

### Instruction manual (Rev-2021-07)

Graphical panel meter for 500V/333mV AC/DC with RGB multi display

**Package contents:** Panel meter Digalox® DPM72-MPN<sup>+</sup>, mounting bracket, 5 jumpers, 2 instruction manuals (EN + DE)

#### 1. Safety instructions

- Read instruction manual carefully before operating the device! Keep for later reference.
- Mounting and installation must be carried out by suitably qualified and competent persons only.
- **WARNING: The measurement inputs of the device can carry life-threatening voltages!**
- **When working on the device hazardous voltages must not be connected to the device! The terminals J1-J12 are not isolated from the measuring circuit.**
- **The device must not be used as the only protective device or protective shutdown.**
- The device is not intended to protect persons or facilities against harm. Specific devices must be used to guarantee safety (protection relays, cut-off switches, etc.).
- When connecting switches to the terminals J1-J8, only switches must be used whose isolation voltage is at least twice the maximum occurring measurement voltage. For example, when measuring 250 V AC switches must be isolated for at least 500 V.
- Do not open the housing!
- Do not use the device in the presence of explosive or flammable substances!
- All cables carrying hazardous voltages must be secured with external separators.

#### 2. Meaning of symbols



General warning sign  
(Attention, observe the documentation!)



Warning of an electrical hazard

### 3. Intended use

- Measurement of current, voltage, power and frequency in the specified measuring ranges.
- Indoor use non condensing, non corrosive.
- Panel mounting.
- In operation, supply the device preferably via screw terminals with 12 to 24 V AC/DC instead of via USB.
- Failure to comply with these instructions will void all guarantee and warranty.

### 4. Description

The multi display with RGB backlight is able to display up to four parameters simultaneously. Thresholds can be associated with individual warning backlight colours. A variety of measurement types (volt AC/DC, ampere AC/DC via external shunt, frequency, power, cos phi) are supported. The unit can be switched between display values via an external switch. Minimum and maximum values of up to four parameters are recorded and can be displayed optionally using an external switch. Measured values are recorded over a time span of 36 seconds up to 14 days. The time base as well as the display of the measuring history can be switched by an external switch. The measured values remain stored as long as the device is supplied with voltage.

The following parameters can be adjusted using the configuration software “Digalox<sup>®</sup> Manager”: scale endpoint, scale caption, display style (pointer, tachometer, bar graph, and more), splash image, backlight colour, thresholds for alarm output, threshold warning colour (light, blink), hysteresis, and more. Recorded measurement values can be read and a continuous transmission of up to four measurement values can be enabled. Using the software, values can be viewed and exported as CSV file. Depending on the model, measured values can be transmitted via USB, XBEE radio technology or RS485 Modbus interface. In addition, the devices feature a counting function with data retention. This enables operating-hours-counters or time-counters for exceeding and falling below threshold values, as well as ampere-hour and energy meters.

Visit **[www.digalox.com](http://www.digalox.com)** to download the software “Digalox<sup>®</sup> Manager”.

## 5. Product overview

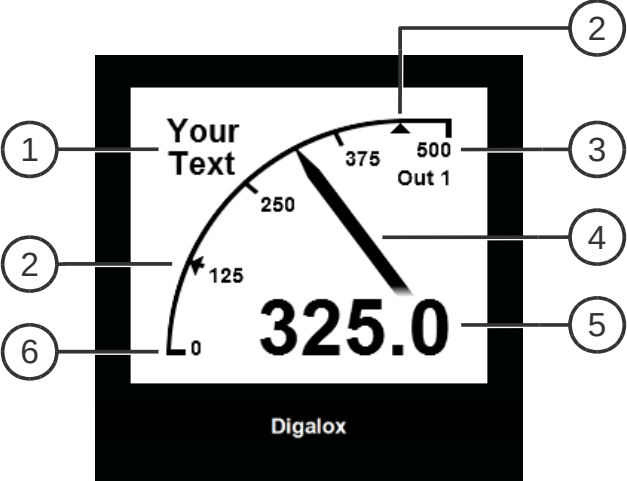
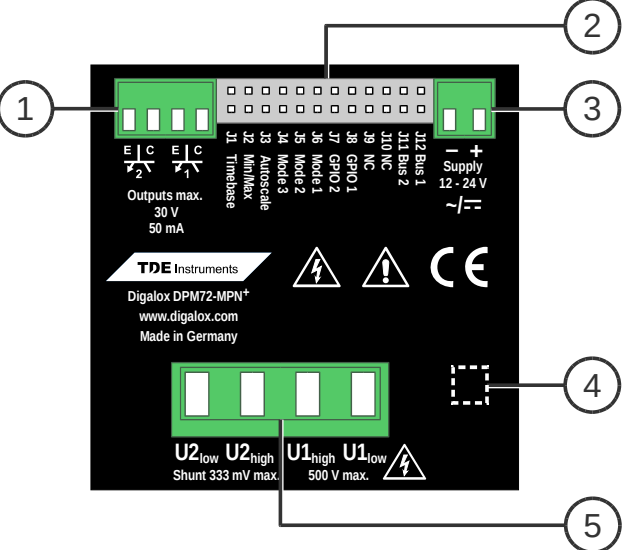
	<p><b>Front</b></p> <ol style="list-style-type: none"> <li>1 Unit or free text</li> <li>2 Threshold values</li> <li>3 Upper scale caption</li> <li>4 Graphical measurement display</li> <li>5 Digital measurement value</li> <li>6 Lower scale caption</li> </ol>
	<p><b>Back</b></p> <ol style="list-style-type: none"> <li>1 2 optocoupler switch outputs</li> <li>2 Jumper pins J1–J12 for activating/switching of graphical historic data display, min/max display, auto-scaling, display value (mode), ...</li> <li>3 Supply voltage input</li> <li>4 Interface (USB Micro-B / XBEE / RS485)</li> <li>5 Measurement inputs</li> </ol>

## 6. Mounting

Carefully insert the device into the panel cut-out. Insert the mounting bracket from the back and push towards the panel until the device sits tight. Make sure the mounting bracket is snapped into the side of the housing. To ensure IP65 protection (dust and water jet) when mounting in a front panel, use optional gasket (separately available).

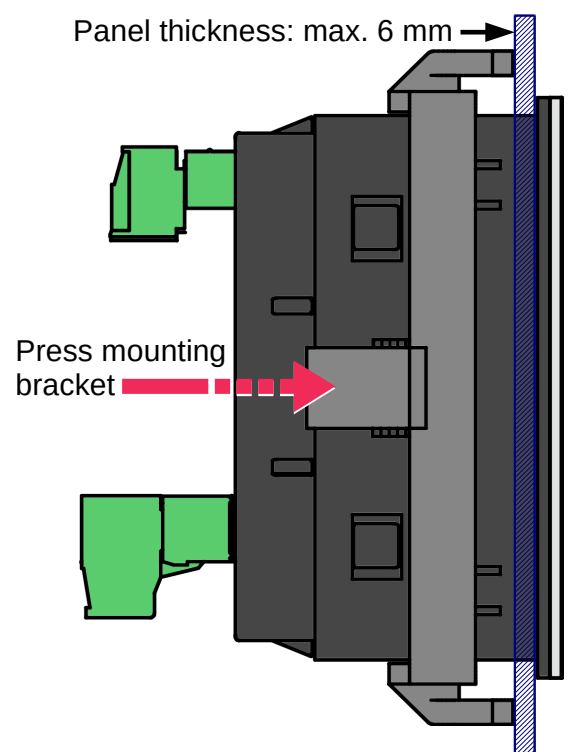

## 7. Electrical connections

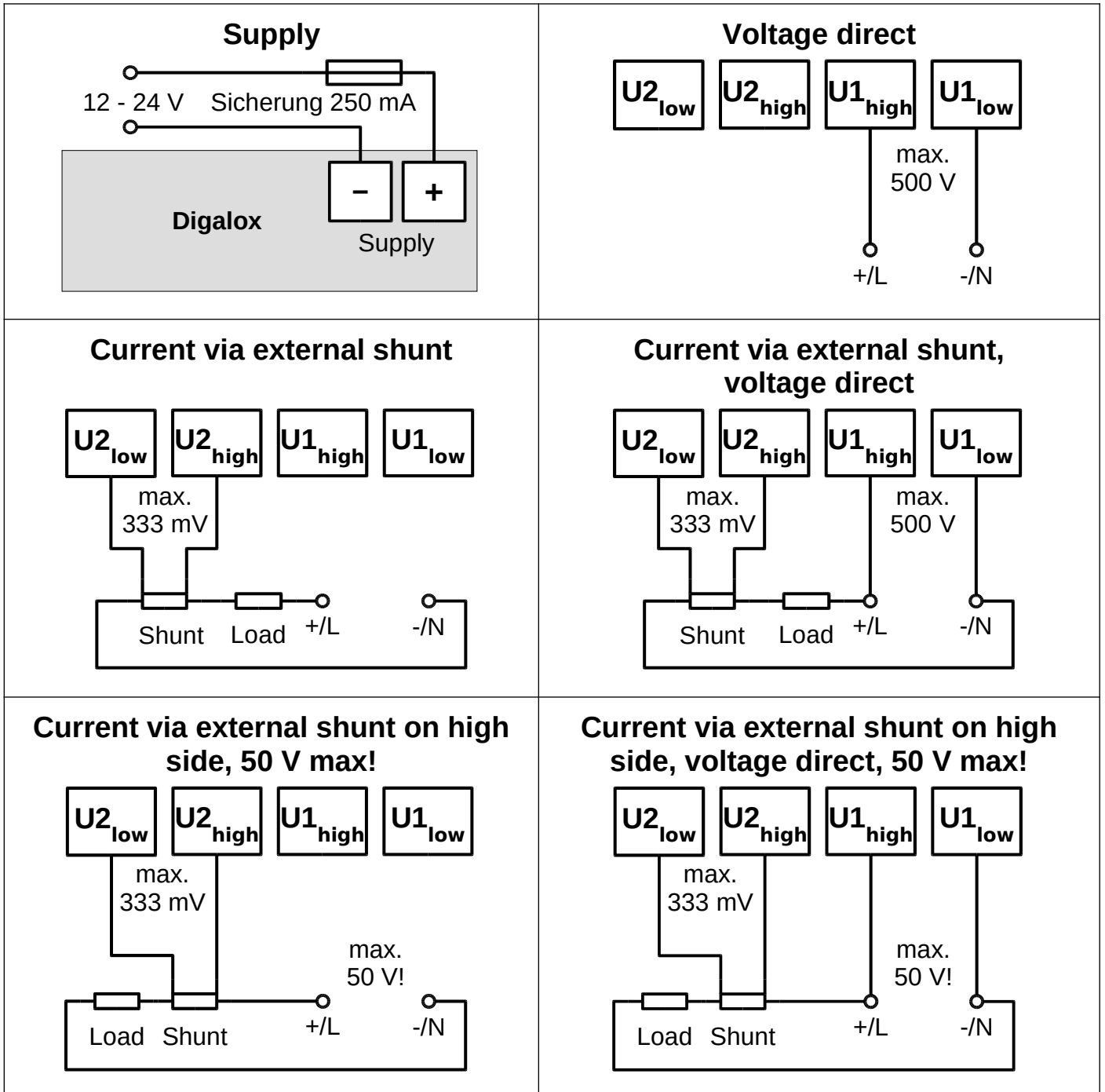

**WARNING:** The device may only be operated in one of the connection options shown above! When measuring current, an external shunt must be connected to U2!



**DANGER:** Current measurement on the high side (between plus and load) only for voltages up to 50 V! In this case the entire device is on high potential. Particularly to be considered when connecting switches to J1-12.

## 8. Configuration

Connect the device to a computer:



**USB:** Connect the device and the computer using a USB cable. The device driver is installed automatically if the computer is connected to the Internet.

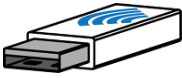

**XBEE:** Insert the XBEE stick into the computer. The device driver is installed automatically if the computer is connected to the Internet. In order to reset the XBEE settings, short-circuit terminal J8.







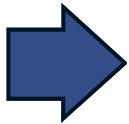

**RS485:** Short-circuit terminal J8. Disconnect the device from the Modbus network and connect it to the computer using an RS485 USB adapter. After completing the configuration, open J8 again.

Start the "Digalox® Manager" software and connect it to the device. Settings can then be made on the various tabs and saved in the device.

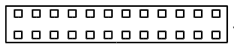

**After restart, the device always shows the first display value or the one that is selected by the jumpers J4-J6 (see table "display value"), in case of a multi display style additionally the following display values.**

*Table display value (factory preset, can be changed by software)*

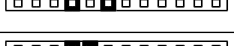
	Display value	Display	Selection
1	V DC direct	Volt DC	J1  J12
2	A DC scaled (with shunt)	Ampere DC	J1  J12
3	P DC scaled (with shunt)	Watt DC	J1  J12
4	V AC direct	Volt AC	J1  J12
5	A AC scaled (with shunt)	Ampere CT	J1  J12
6	P AC scaled (with shunt)	Watt CT	J1  J12
7	AC Frequency	Freq. AC	J1  J12

**Note:** When using a multi display style, AC and DC measurement cannot be done simultaneously. The first display value used defines the type of measurement.

## 9. Other settings

The following functions can be activated independently during operation by short-circuiting connectors J1-J3, e.g. using a jumper or switch:

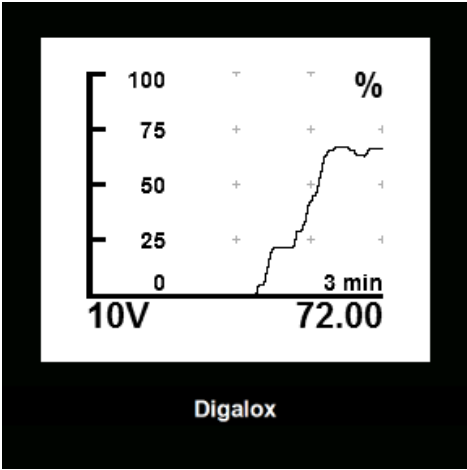
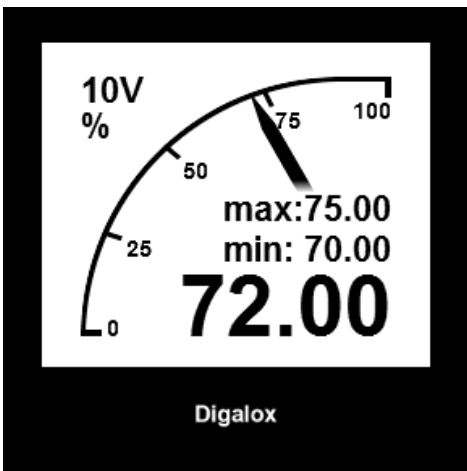
	<p><b>J1: Graphical historic data display</b></p> <p>The unit displays the stored values within the set time base as a graphical trend. The time base can be set to days (7, 14), hours (1, 3, 6, 12, 24, 48, 72), minutes (3, 15, 30) or seconds (36).</p> <p>The time base can be changed by alternately opening and closing J1 (interval &lt; 2 sec). When first opening and closing J1 the current time base is displayed. For each subsequent opening and closing the time base changes to the next setting. In order to save the setting permanently, the software “Digalox® Manager” has to be used.</p>
	<p><b>J2: Min-Max display</b></p> <p>The display shows the maximum and minimum values recorded since the last reset. The values can be reset by opening and closing connection J2 shortly (interval &lt; 2 sec). The display shows “Minmax reset”.</p>
	<p><b>J3: Auto-scaling</b></p> <p>The device automatically changes the upper scale caption depending on the current measuring value, e.g. between 10, 100 and the set upper scale caption.</p>

## 10. Maintenance

Periodically check all external cable connections.

## 11. Cleaning

Observe the safety instructions before cleaning the device. Clean the device with a dry lint-free soft cloth. Do not use solvents.

## 12. Specification

Supply	12 - 24 V AC/DC $\pm 10\%$ (50/60 Hz $\pm 10\%$ ) or if applicable via USB, galvanically isolated
Power consumption	Max. 2.4 W
Display	LCD graphic display 192 × 160 pixels, 16 grey levels with RGB backlight
Voltage measurement:	
Measuring range	$\pm 500$ V AC/DC, 10 - 500 Hz
Accuracy	$\pm 1$ % true RMS
Internal resistance	2.6 M $\Omega$
Ampere measurement via shunt:	
Measuring range	$\pm 333$ mV AC/DC, 10 - 500 Hz
Accuracy	$\pm 1$ % true RMS
Internal resistance	20 k $\Omega$
Short-term load	1 V (< 10 s)
Frequency measurement:	
Measuring range	10 - 1000 Hz
Accuracy	$\pm 0.1$ Hz
Measuring value update	5 Hz (32 kHz sampling rate)
Recording of measurement	36 seconds to 14 days, 180 internal memory locations
Alarm outputs	2 optocoupler outputs max. 30 V DC, 50 mA
Connections (measuring inputs) - Wire gauge - Wire strip length - Pitch	0.2 - 3.3 mm <sup>2</sup> (24 to 12 AWG) 7 - 8 mm 7.62 mm
Connections (supply, alarm outputs and RS485) - Wire gauge - Wire strip length - Pitch	0.13 - 1.3 mm <sup>2</sup> (26 to 16 AWG) 6 - 7 mm 3.5 mm
Operating temperature	0 °C to +50 °C
Storage temperature	-20 °C to +70 °C
Operating altitude	0 to 2000 m above sea level
IP code	IP65 (front), IP00 (back)
Dimensions	72 mm × 72 mm × 58 mm
Panel cut-out	68 mm × 68 mm

Mounting depth	55.3 mm (with plugs, cable direction rear facing) 72.6 mm (with antenna)
Net weight	149 g

### 13. Dimensions [mm]

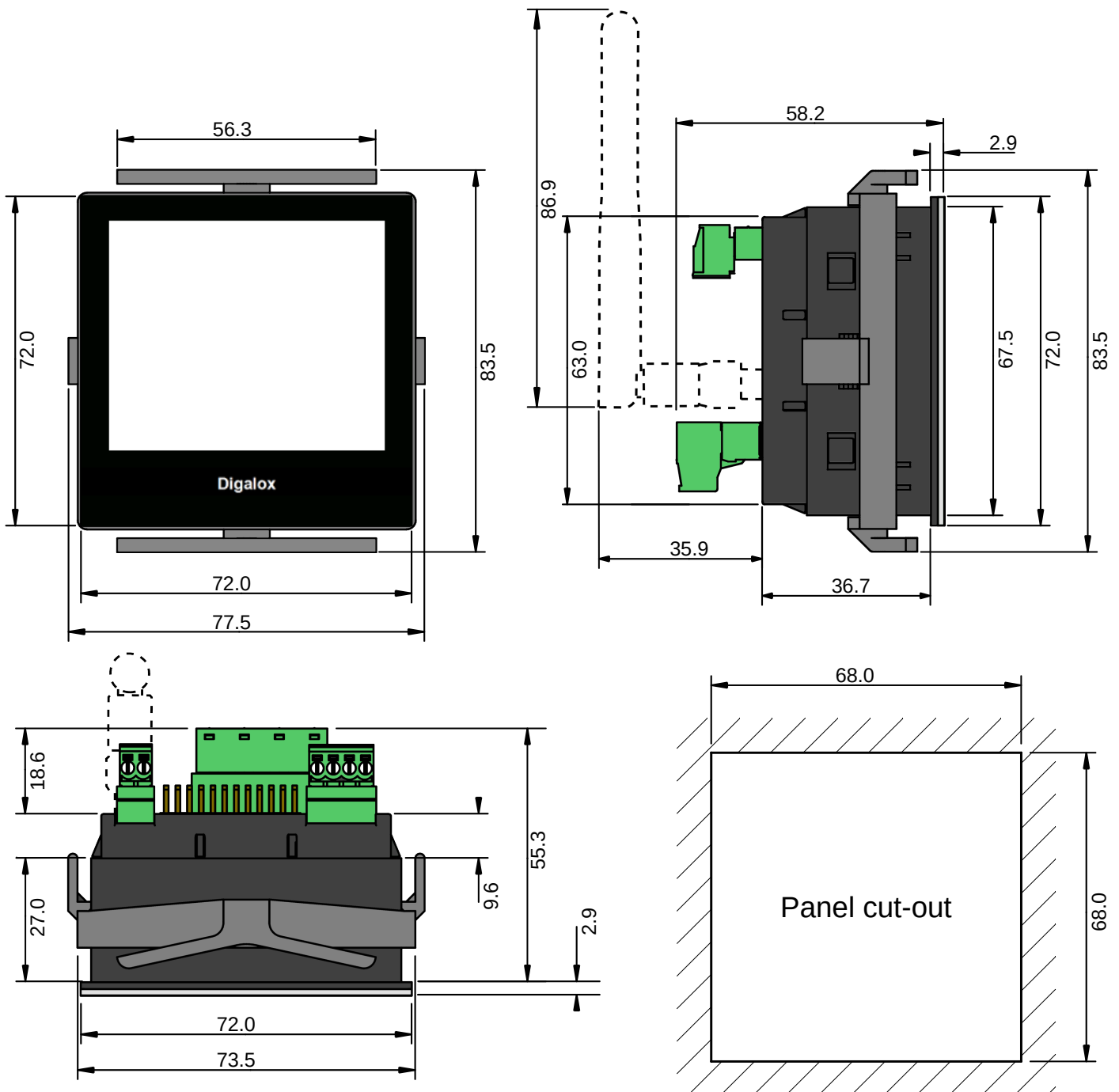

### 14. Available accessories

TDE Instruments Digalox® DPM72 gasket EPDM/SBR

### 15. Contact information

TDE Instruments GmbH, Gewerbestraße 8, D-71144 Steinenbronn

Phone: +49 7157 20801

E-mail: [info@tde-instruments.de](mailto:info@tde-instruments.de)

Internet: [www.tde-instruments.de](http://www.tde-instruments.de), [www.digalox.com](http://www.digalox.com)